



# BRUSHLESS Medium And Low Torque AUTOMATIC SCREWDRIVER

Smart Torque Display Tool





KILEWS INDUSTRIAL CO., LTD. was established in July 1984. The company began with USD\$1,000,000 investment and six staff. We created the KILEWS as our trademark with the most professional techniques for making automatic electric screwdrivers to the world.

**In 1988**, our investment grew to USD\$170,000 and we decided to expand international markets, especially for Asia region.

**In 1990**, based on increasing demand for KOREA market, KILEWS set up the electric screwdriver assembling plant in INCHON, KOREA.

**In 1992**, with the approval of Investment Commission, MOEA, the company invested US\$200,000 to TIANJIN TAIWEI INTERNATIONAL TRADING CO., LTD. for international trading and Northern China Customer Service Center of KILEWS.

**In July 1994**, KILEWS (CHINA) CUSTOMER SERVICE CENTER was established in SHEN-ZHEN, KUAN-CHOU of China and KILEWS (H.K.) TRADING COMPANY in December in Hong Kong.

**In January 1995**, KILEWS completed building a new plant in Hsin-Chuang Dist., New Taipei City, Taiwan, R.O.C., the capital was increased to USD\$350,000 at the same time with 46 staff through professional automatic equipment to sell our products all over the world.

**In 1996**, KILEWS established two China offices- TUNG-GUAN OFFICE in April and Central China Customer & Service Center, Shanghai in October.

**In February 1997**, KILEWS MARKETING (S.E.A)(SINGAPORE) was established to sell and provide service in South –Eastern Asia.

**In January 1998**, AC230V electric screwdriver has been approved the certification of CE from ITS. UK. which allowed KILEWS formally entering into the EUROPE markets. In June, acquired “the Chinese chang cheng Certification” to meet the demand of mainland China’s widely market. In December, AC115V acquired UL approval to strengthen the competition and satisfy the American markets’ demand.

KILEWS acquired three certifications in 1998 CE from ITS, UK. In January , Chinese Chang Cheng, China in June and UL of USA in December.

**In April 1999**, in order to satisfy increasing demand of EUROPE and UNITED STATES markets, the total capital has added to USD \$1,000,000 and increased the offshore staff at about 200 excluding 85 in Taiwan.

**In August 2000**, in order to further expand the CHINA market, KILEWS increased the capital to USD\$3,000,000 and established KILEWS Electric Tools (Shanghai) Co., Ltd. which manufacture electric screwdrivers for the needs of Chinese Market.

**In September 2000**, KILEWS acquired CE, CULUS certification on DC type 32V series electric screwdriver and Power Controller.

**In December 2002**, KILEWS Electric Tools (Shanghai) CO., LTD. was approved as ISO9001 manufacturer in China.

**In January 2003**, KILEWS products passed and acquired the CCC certificates by China CQC.

**In January 2005**, KILEWS Electric Tools (VIETNAM) CO., Ltd. was set up in Vietnam.

**In October 2007**, KILEWS new factory was set up in Taiwan and soon become one of biggest suppliers of electric screwdriver in the world.

**In October 2008**, the company held a grand opening of new plant in Taiwan for preparation of being a leading supplier of electric screwdrivers all over the world.

**In January 2009**, KILEWS self-researched, developed and produced brushless motor, entering the new generation of the small-size brushless motor. In March of the same year, KILEWS developed co-product for the brushless screwdriver application such as counter, low recoil force screwdriver....etc.

**In 2010**, Brushless technology was officially produced and promoted in Shanghai China and soon became the highest sale in the power tool market.

**In 2011**, KILEWS self-researched and developed automatic industrial brushless power torque screwdriver series. Focus on the convenience for the users and increase power saving, also design for energy conservation and environmental protection as well.

**In 2012**, Accomplished the development of cordless screwdriver series’ product line, self-researched and developed automatic/semi-automatic / impact series industrial brushless cordless screwdriver and light weight, high speed automatic cordless brushless screwdriver.

**In October 2012**, KILEWS SKD-BE Series won the National Brand of Yushan Award, the award for outstanding business class award for the best product.

**In October 2015**, KILEWS established KILEWS WEST INC.

**In October 2016**, Develop and manufacture industrial 4.0 products, and become international leading brand.

**In October 2017**, Smart Torque Display Tool System won 2017 Taiwan Excellence Award in October.

**In October 2018**, Industrial Smart Counting Controller System, Smart Torque Display Electric Screwdriver series, DC built-in counter brushless electric screwdriver series and DC Micro Torque Brushless Screwdriver series won 2018 Taiwan Excellence Award.



# Index



TABLE OF ALL MODELS / TORQUE OF ALL MODELS .....	03
SMART INDUSTRIAL TORQUE DISPLAY	
KL-CTDS.....	04
SMART INDUSTRIAL TORQUE DISPLAY	
KL-MCTDS5.....	05
POWER CONTROLLER (FOR BRUSHLESS SCREWDRIVERS)	
SKP Series SKP-12HL, SKP-32BC-60W, SKP-BE32HL(6P).....	06
BRUSHLESS MINI TORQUE DC-TYPE AUTOMATIC TRIGGER START CLUTCH TYPE SERIES	
SKD-B100 Series .....	07
BRUSHLESS MINI TORQUE DC-TYPE AUTOMATIC PUSH BUTTON START CLUTCH TYPE SERIES	
SKD-B123KLM.....	08
BRUSHLESS LOW TORQUE DC-TYPE AUTOMATIC TRIGGER AND PUSH START CLUTCH TYPE SERIES	
SKD-BN200 Series .....	09
BRUSHLESS MEDIUM TORQUE DC-TYPE AUTOMATIC TRIGGER AND PUSH START CLUTCH TYPE SERIES	
SKD-BN500 Series .....	10
BRUSHLESS LOW TORQUE DC-TYPE AUTOMATIC WITH COUNTER TRIGGER AND PUSH START CLUTCH TYPE SERIES	
SKD-BE200 Series .....	11
BRUSHLESS MEDIUM TORQUE DC-TYPE AUTOMATIC WITH COUNTER TRIGGER AND PUSH START CLUTCH TYPE SERIES	
SKD-BE500 Series .....	12
BRUSHLESS LOW TORQUE DC-TYPE AUTOMATIC VACUUM SCREWDRIVERS	
SKD-BN200 (VACUUM TYPE) Series.....	13
BRUSHLESS MEDIUM TORQUE DC-TYPE AUTOMATIC VACUUM SCREWDRIVERS	
SKD-BN500 (VACUUM TYPE) Series.....	14
BRUSHLESS HIGH TORQUE DC-TYPE AUTOMATIC TRIGGER AND PUSH START CLUTCH TYPE SERIES	
SKD-BN7000 Series .....	15
BRUSHLESS MEDIUM TORQUE AC-TYPE AUTOMATIC TRIGGER AND PUSH START CLUTCH TYPE SERIES	
SK-B5 Series .....	16
BRUSHLESS HIGH TORQUE AC-TYPE AUTOMATIC TRIGGER AND PUSH START CLUTCH TYPE SERIES	
SK-B6 Series .....	17
SCREW COUNTER (FOR BRUSHLESS SCREWDRIVERS)	
INTRODUCTION/FEATURES.....	18
SCREW COUNTER (FOR BRUSHLESS SCREWDRIVERS)	
SKP-BC32HL-100 Counter / Power Supply / Slow-Start.....	19
TORQUE METERS	
KTM-6, KTM-15, KTM-150.....	20
SCREW FEEDER (FOR VACUUM TYPE SCREWDRIVER AND AUTOMATION SYSTEM)	
KFA-0820 Series KFA-0820A, KFA-0820H.....	21
SCREW FEEDER (FOR VACUUM TYPE SCREWDRIVER AND AUTOMATION SYSTEM)	
KFA-0830 / KFA-0850 Series KFA-0850A, KFA-0850H.....	22
SCREW FEEDER	
KFR-1050.....	23
ACCESSORIES	
Auxiliary Arm KP Series KP-AUX-C/E/B/D.....	24
ACCESSORIES	
Screwdriver I/O Signal Control Box (For Manual / PLC) · Slow Start Control Module · 90 Degree Attachment KL-SCBSN, KL-SSBN, KL-1, KL-2, KZ-1, KL-M-1, KL-M-2.....	25
ACCESSORIES	
Screwdriver Holder, Torque Locker, Spiral Cables, Torque Adjuster, Pistol Grip, Screw Setter, Spring Balancer Series.....	26

## TABLE OF ALL MODELS

Page	Series	Model	Torque (kgf.cm)	Speed (r.p.m)	Screw Size (mm)	Power Controller
P7~8	SKD-B100	SKD-B100L	0.08~1.5	1000/700	1.0~1.7	SKP-12HL
		SKD-B103L	0.5~3.5	1000/700	1.0~2.3	SKP-12HL
		SKD-B100LS4	0.08~1.5	280/200	1.0~1.7	SKP-12HL
		SKD-B103LS4	0.5~3.5	280/200	1.0~2.3	SKP-12HL
		SKD-B123KLM	0.2~2.0	1000/700	1.0~1.7	SKP-12HL
P9	SKD-BN200	SKD-BN/BNK203L	0.2~3.5	1000/700	1.0~2.3	SKP-32BC-60W(N)/SKP-BE32HL(N)
		SKD-BN203LS5	0.2~3.5	500/350	1.0~2.3	SKP-32BC-60W(N)
		SKD-BN203LS6	0.2~3.5	370/260	1.0~2.3	SKP-32BC-60W(N)
		SKD-BN203LS7	0.2~3.5	230/160	1.0~2.3	SKP-32BC-60W(N)
		SKD-BN/BNK207L	0.5~7	1000/700	1.4~2.6	SKP-32BC-60W(N)/SKP-BE32HL(N)
		SKD-BN/BNK210L/P	L : 1~10 / P : 2~10	1000/700	1.6~3.0	SKP-32BC-60W(N)/SKP-BE32HL(N)
P10	SKD-BN500	SKD-BN/BNK512L	1.5~12	1000/700	1.6~3.0	SKP-32BC-60W(N)/SKP-BE32HL(N)
		SKD-BN/BNK512P	2~12	1000/700	1.6~3.0	SKP-32BC-60W(N)/SKP-BE32HL(N)
		SKD-BN/BNK512LF	1.5~12	2000	1.6~3.0	SKP-BE32HL(N)
		SKD-BN/BNK512PF	2~12	2000	1.6~3.0	SKP-BE32HL(N)
		SKD-BN/BNK517LF/PF	3~17	2000	1.6~3.0	SKP-BE32HL(N)
		SKD-BN/BNK519L/P	3~19	1000/700	2.3~3.5	SKP-32BC-60W(N)/SKP-BE32HL(N)
P11	SKD-BE200	SKD-BE203L	0.2~3.5	1000/700	1.0~2.3	SKP-32BC-60W(N)
		SKD-BE203LS5	0.2~3.5	500/350	1.0~2.3	SKP-32BC-60W(N)
		SKD-BE203LS6	0.2~3.5	370/260	1.0~2.3	SKP-32BC-60W(N)
		SKD-BE203LS7	0.2~3.5	230/160	1.0~2.3	SKP-32BC-60W(N)
		SKD-BE207L	0.5~7	1000/700	1.4~2.6	SKP-32BC-60W(N)
		SKD-BE210L/P	L : 1~10 / P : 2~10	1000/700	1.6~3.0	SKP-32BC-60W(N)
P12	SKD-BE500	SKD-BE512L	1.5~12	1000/700	1.6~3.0	SKP-32BC-60W(N)
		SKD-BE512P	2~12	1000/700	1.6~3.0	SKP-32BC-60W(N)
		SKD-BE512LF	1.5~12	2000	1.6~3.0	SKP-BE32HL(N)
		SKD-BE512PF	2~12	2000	1.6~3.0	SKP-BE32HL(N)
		SKD-BE517LF	3~17	2000	1.6~3.0	SKP-BE32HL(N)
		SKD-BE517PF	3~17	2000	1.6~3.0	SKP-BE32HL(N)
		SKD-BE519L	3~19	1000/700	2.3~3.5	SKP-32BC-60W(N)
		SKD-BE519P	3~19	1000/700	2.3~3.5	SKP-32BC-60W(N)
P13	SKD-BN200 (VACUUM TYPE)	SKD-BN203L(VACUUM TYPE)	0.2~3.5	1000/700	1.0~2.3	SKP-32BC-60W(N)
		SKD-BN207L(VACUUM TYPE)	0.5~7	1000/700	1.4~2.6	SKP-32BC-60W(N)
		SKD-BN210L(VACUUM TYPE)	1~10	1000/700	1.6~3.0	SKP-32BC-60W(N)
P14	SKD-BN500 (VACUUM TYPE)	SKD-BN512L(VACUUM TYPE)	1.5~12	1000/700	1.6~3.0	SKP-32BC-60W(N)
		SKD-BN519L(VACUUM TYPE)	3~19	1000/700	2.3~3.5	SKP-32BC-60W(N)
		SKD-BN517LF(VACUUM TYPE) SKD-BN512LF(VACUUM TYPE)	3~17 1.5~12	2000 2000	1.6~3.0 1.6~3.0	SKP-BE32HL(N) SKP-BE32HL(N)
P15	SKD-BN7000	SKD-BN7022LF/PF	5~22	2000	2.6~4.0	SKP-BE32HL(N)
		SKD-BN7030L/P	10~30	1200	2.6~4.0	SKP-BE32HL(N)
P16	SK-B5	SK-B5112L/P	L:1.5~12 / P:2~12	1200	1.6~3.0	
		SK-B5112LF/PF	L:1.5~12 / P:2~12	2000	1.6~3.0	
		SK-B5117LF/PF	3~17	2000	1.6~3.5	
		SK-B5122L/P	4~22	1200	2.3~4.0	
		SK-B5212L/P	L:1.5~12 / P:2~12	1200	1.6~3.0	
		SK-B5212LF/PF	L:1.5~12 / P:2~12	2000	1.6~3.0	
		SK-B5217LF/PF	3~17	2000	1.6~3.5	
P17	SK-B6	SK-B6125L/P	5~25	1000	2.6~4.0	
		SK-B6125LF/PF	5~25	2000	2.6~4.0	
		SK-B6150L/P	20~50	1000	4.0~5.0	
		SK-B6230L/P	10~30	1200	2.6~4.0	
		SK-B6230LF/PF	10~30	2000	2.6~4.0	
		SK-B6250L/P	20~50	1200	4.0~5.0	

# KILEWS INDUSTRY 4.0

## Smart Industrial Torque Display

### KL-CTDS



KL-CTDS

### External Dimension

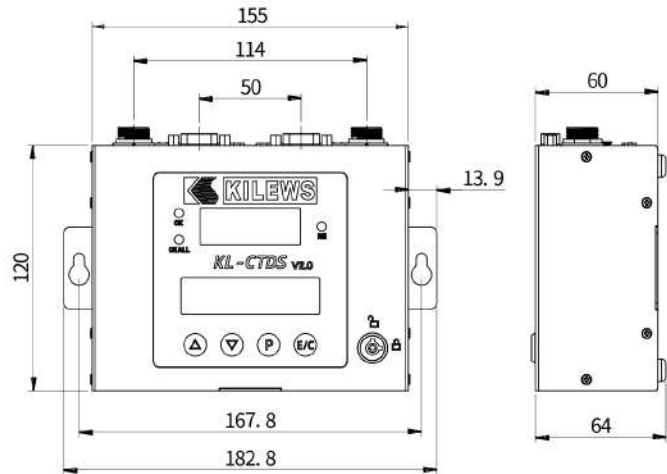

KL-CTDS

### Features

In the era of industry 4.0, assembly data collection and integration is becoming a must. In order to meet market demands, Kilews's latest invention KL-CTDS is able to display tightening torque, output tightening torque, output tightening status, storage tightening torque and together with error proof functions.

KL-CTDS is also able to prevent errors from tightening torque, tightening number of threads, and tightening time. With various I/O, KL-CTDS can be connected to your PLC and integrated with your automation equipment and output assembly status instantly to your sever or private could by ethernet or WIFI for traceability.



### Specifications

Model	KL-CTDS
Input Voltage	DC 32V/ 40V
I/O Output Voltage	DC 24V 50mA/12V 100mA
Count	1-250
Count method	Count-up / Count-down
Continued induction switch(sensor)	ON/OFF
Sensor switch mode	ON(2 Sensors) / OFF(1 Sensor)
Slow start setting time	0~9.9 seconds
Slow start speed setting	L0:100%,10%~90% L1~L9 Rated speed
Detection stop time	0.00~9.99 seconds
Detection torque value	0.0~550.0 kgf.cm
Detection screw thread number	0.0~999.9
External connection input	Forward / Reverse / Disable / Confirm
External comecon output	OK / NG / OK ALL / STOP
Serial interface	RS-232X2
Assembly management	KL-DAS / KL-AMS
external dimensions	155X120X60(mm)
Weight(g)	630g
Accessories	Power cableX1 KeyX2
Applicable Models	SKD-BNK200 series SKD-BNK500 series



TAIWAN  
EXCELLENCE  
2019



**KL-MCTDS5**



### External Dimension

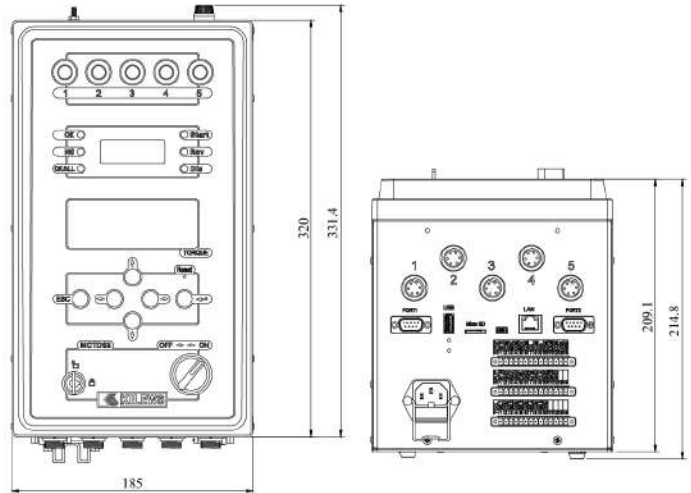

**KL-MCTDS5**

### Features

- 4 digits and 7 Segment of torque display
- 24x4 LCM display settings
- Password and key control to avoid operator adjusting settings.
- Counting preference set up (count up and count down)
- Slow start time 0.0-9.9 sec
- Slow start speed (10%~90%, L1~L9)
- Workpiece in place sensor (on/off)
- Set up fastening thread range
- I/O signal (mos-relay)
- RS-232 interface for data output, storage and use with barcode scanner
- 99 data storage
- Set up fastening time range
- Set up fastening torque range
- Error code
- Auto learning
- Change torque unit
- Offset setting
- External start
- External reverse
- External disable tool
- External confirm
- Slot for SD memory card
- Built-in power
- Ethernet
- 99 sequences set up

### Specifications

Model	KL-MCTDS5
Input Voltage	AC 100V ~ 240V
I/O Output Voltage	DC 24V 50mA / 12V 100mA
Count	1-99
Count method	Count-up / Count-down
Continued induction switch(sensor)	ON/OFF
Sensor switch mode	ON(2 Sensors) / OFF(1 Sensor)
Slow start setting time	0~9.9 seconds
Slow start speed setting	L0:100%,10%~90% L1~L9 Rated speed
Detection stop time	0.00~9.99 seconds
Detection torque value	0.0~550.0 kgf.cm
Detection screw thread number	0.0~999.9
External connection input	Forward / Reverse / Disable / Confirm
External comectron output	OK / NG / OK ALL / STOP
Serial interface	RS-232X2
Assembly management	KL-DAS / KL-AMS
external dimensions	185 x320x209(mm)
Weight(g)	5.55Kg
Accessories	Power cableX1 KeyX2

#### Applicable Models

SKD-BNK200 series  
SKD-BNK500 series

# POWER CONTROLLER (FOR BRUSHLESS SCREWDRIVERS)



SKP Series [SKP-12HL, SKP-32BC-60W, SKP-BE32HL(6P)]

## External Dimension



SKP-12HL

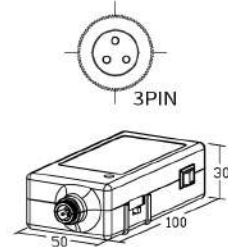

SKP-12HL



SKP-32BC-60W



SKP-BE32HL(6P)

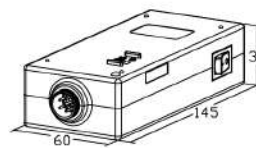

SKP-32BC-60W

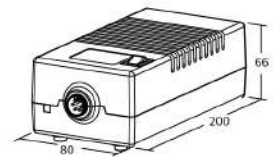

SKP-BE32HL(6P)

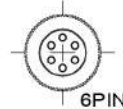

6PIN



6PIN

## Specifications

Model	SKP-12HL	SKP-32BC-60W	SKP-BE32HL(6P)
Input Voltage	AC 100-240V 50/60Hz	AC 100-240V 50/60Hz	AC 100-240V 50/60Hz
Output Voltage	LO DC 9V / HI DC 12V	LO DC 24V / HI DC 32V	LO DC 24V / HI DC 32V
Capacity	2.5A	1.8A MAX	3A MAX
Outside Dimensions	100X50X35(mm)	145X60X35(mm)	200X80X66(mm)
Weight(g)	144.5g(main body)	250g(main body)	460g(main body)
AC Cord Length	2M with ground	2M with ground	2M with ground

Remark (optional)



Applicable Models

SKD-B100 Series

SKD-BN200 Series  
SKD-BE200 Series  
SKD-BN500 Series  
(not included F type series)  
SKD-BE500 Series  
(not included F type series)

SKD-BN200 Series  
SKD-BNK200 Series  
SKD-BE200 Series  
SKD-BN500 Series  
SKD-BNK500 Series  
SKD-BE500 Series  
SKD-BN7000 Series

## Plug Feature

(U.S.A plug)

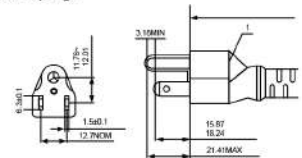

(EUROPE plug)

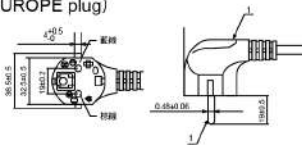

(INDIA plug)

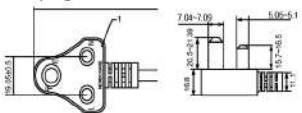

(AUSTRALIA plug)

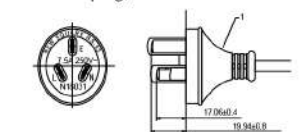

(U.K plug)

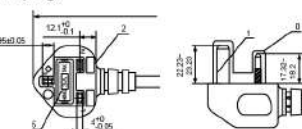

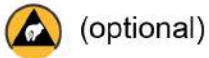

First smallest brushless DC-12V screwdriver in the world

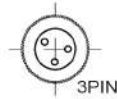

- Adopting the high function of innovation and brushless feature. Durable and permanent life-time. Motor maintenance is unnecessary.
- Small and light weight, noiseless, streamlined appearance, high stability and easy to use.
- First creation of the most smallest and lightest brushless feature.
- First innovation of Forward/Reverse switch modes. Screws can be loosed easily just in a moment without switching the switches' modes.
- Two lowest torque specifications: 0.08~1.5Kgf.cm / 0.5~3.5Kgf.cm. Best choice for producing high precision products, such as watches, high precision hard-driver and etc.
- Certification: ETL and CE

### Specifications

Model		SKD-B100L	SKD-B103L	SKD-B100LS4	SKD-B103LS4
Input Voltage		DC9V or DC12V			
Torque	(kgf.cm)	0.08~1.5	0.5~3.5	0.08~1.5	0.5~3.5
	(Lbf.in)	0.07~1.33	0.44~3.01	0.07~1.33	0.44~3.01
	(N.m)	0.008~0.15	0.05~0.34	0.008~0.15	0.05~0.34
Repeatable Torque Accuracy(%)		±5% (torque test in scale 3 with auxiliary arm)			
Torque Adjustment		Stepless			
Free Speed (r.p.m)	HI	1000	1000	280	280
	LO	700	700	200	200
Screw Size Dia (mm)	Machine Screw	1.0~1.7	1.0~2.3	1.0~1.7	1.0~2.3
	Tapping Screw	1.0~1.5	1.0~2.0	1.0~1.5	1.0~2.0
Weight(g)		170			
Length(mm)		165			
Power Controller		SKP-12HL			
ESD(Anti-Static)		✓ (with black housing)			
CE		✓			
RoHS		✓			
Bit Type					

### External Dimension

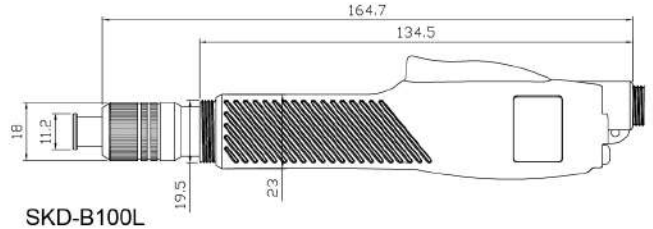

### Torque Range Reference Chart

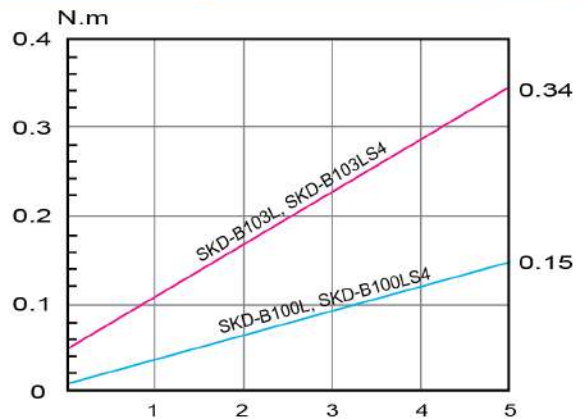

### Accessories



### Power Controller Specification

Model	SKP-12HL
Input Voltage	AC100~240V 50/60Hz
Output Voltage	Lo DC9V / Hi DC12V
Capacity	2.5A
Size	105X50X35
Weight	144.5g
Cord Length	2M





# BRUSHLESS MINI TORQUE DC-TYPE AUTOMATIC PUSH BUTTON START CLUTCH TYPE SERIES SKD-B123KLM



## External Dimension

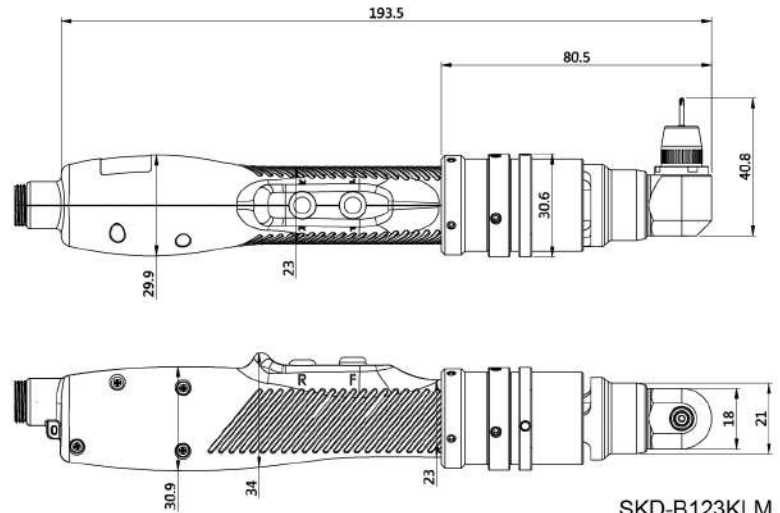

SKD-B123KLM

- Adopting the high function of innovation and brushless feature. Durable and permanent life-time. Motor maintenance is unnecessary.
- Small and light weight, noiseless, streamlined appearance, high stability and easy to use.
- First creation of the most smallest and lightest brushless feature.
- First innovation of Forward/Reverse switch modes. Screws can be loosed easily just in a moment without switching the switches' modes.
- Best choice for producing high precision products, such as watches, high precision hard-driver and etc.

## Torque Range Reference Chart

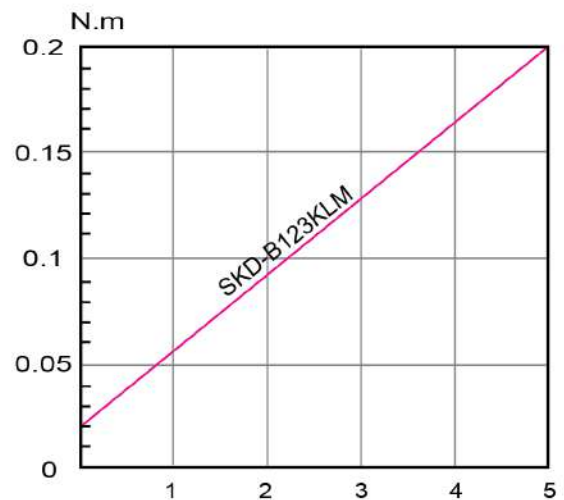

## Specifications

Model		SKD-B123KLM
Input Voltage		DC9V or DC12V
Torque	(kgf.cm)	0.2~2.0
	(Lbf.in)	0.17~1.7
	(N.m)	0.02~0.2
Torque Adjustment		Stepless
Free Speed (r.p.m)	HI	1000
	LO	700
Screw Size Dia (mm)	Machine Screw	1.0~1.7
	Tapping Screw	1.0~1.5
Weight(g)		245
Length(mm)		202.9
Power Controller		SKP-12HL
ESD(Anti-Static)		-
CE		-
RoHS		-
Bit Type		



# BRUSHLESS LOW TORQUE DC-TYPE AUTOMATIC TRIGGER AND PUSH START CLUTCH TYPE SERIES

## SKD-BN200 / SKD-BNK200 (Apply for torque display series)

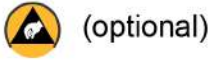

- Adopts High-Functional Brushless Motor, marvelous lifespan and strong durability to repair and maintenance almost needless.
- Smaller size, light weight, low noise-pollution, fashionable design, high stability and easy operation motor which gives the benefit of longer working-time. (3 years warranty on motor)
- Brushless Motor has more stable torque output : It is best to fit for operating in clean-room circumstance and no worry of pollution will be arisen.
- Best tool to assemble watch, laptop, digital camera, DVD player, cell phone, communication equipment and high tech products which need to be assembled in clean-room.
- CE and ETL are optional

### External Dimension

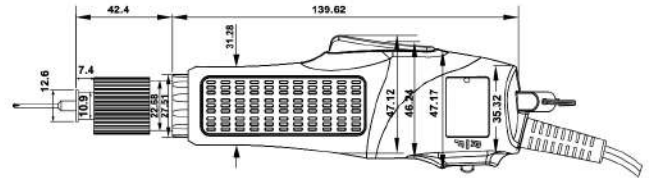

SKD-BN200L

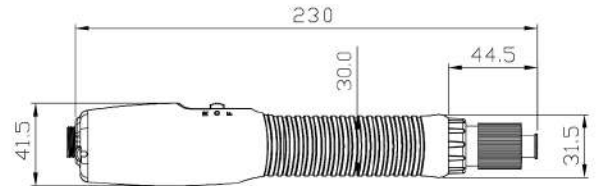

SKD-BN200P

### Torque Range Reference Chart

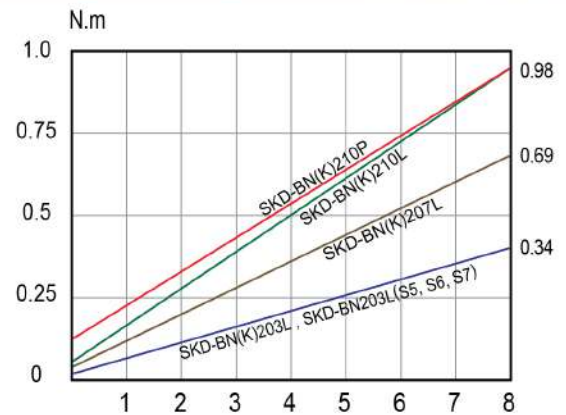

### Specifications

Model	SKD-BN203L SKD-BNK203L	SKD-BN203LS5	SKD-BN203LS6	SKD-BN203LS7	SKD-BN207L SKD-BNK207L	SKD-BN210L/P SKD-BNK210L/P
Input Voltage	DC24V or DC32V					
Power Consumption	25W					
Torque	(kgf.cm)	0.2~3.5	0.2~3.5	0.2~3.5	0.2~3.5	0.5~7 L:1~10 / P:2~10
	(Lbf.in)	0.18~3.01	0.18~3.01	0.18~3.01	0.18~3.01	0.44~6.10 L:0.89~8.67 / P:1.77~8.67
	(N.m)	0.02~0.34	0.02~0.34	0.02~0.34	0.02~0.34	0.05~0.69 L:0.10~0.98 / P:0.2~0.98
Repeatable Torque Accuracy(%)	±3% (torque test in scale 4 with auxiliary arm)					
Torque Adjustment	Stepless					
Free Speed (r.p.m)	HI	1000	500	370	230	1000 1000
	LO	700	350	260	160	700 700
Screw Size Dia (mm)	Machine Screw	1.0~2.3	1.0~2.3	1.0~2.3	1.0~2.3	1.4~2.6 1.6~3.0
	Tapping Screw	1.0~2.0	1.0~2.0	1.0~2.0	1.0~2.0	1.4~2.3 1.6~2.6
Weight(g)	L:330 P:310					
Length(mm)	L:185 P:230					
ESD(Anti-Static)	✓ (with black housing)					
CE	✓					
RoHS	✓					
Bit Type						

### Accessories

**Torque Locker KC-13C**

**Torque Adjuster KW-4**

**Screwdriver Holder KH-5**

**Spring Balancer KL-600**

**Power Controller**

**SKP-BE32HL(6P)**

**SKP-32BC-60W**

※SKD-BN203LS series can not work with KL-SSBN slow start control module

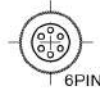
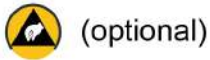

- Adopts High-Functional Brushless Motor, marvelous lifespan and strong durability to repair and maintenance almost needless.
- Smaller size, light weight, low noise-pollution, fashionable design, high stability and easy operation motor which gives the benefit of longer working-time. (3 years warranty on motor)
- Brushless Motor has more stable torque output : It is best to fit for operating in clean-room circumstance and no worry of pollution will be arisen.
- Best tool to assemble watch, laptop, digital camera, DVD player, cell phone, communication equipment and high tech products which need to be assembled in clean-room.
- CE and ETL are optional

### External Dimension

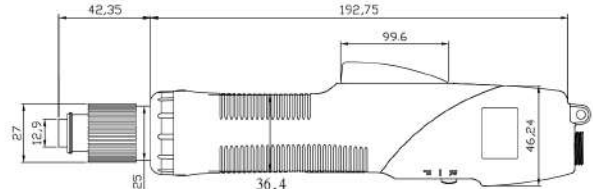

SKD-BN500L

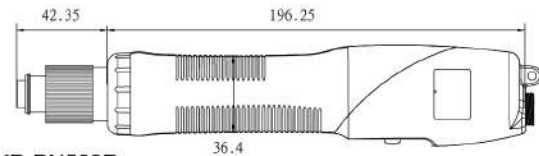

SKD-BN500P

### Torque Range Reference Chart

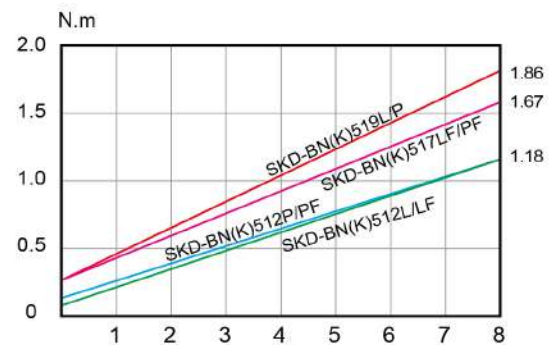

### Accessories

<p>Torque Locker KC-6C</p>	<p>Torque Adjuster KW-3</p>
<p>Screwdriver Holder KH-4</p>	<p>Spring Balancer KL-1200</p>
<p>90 Degree Attachment KL-2</p>	<p>Pistol Grip LG-10, PG-10</p>
<p>Power Controller SKP-BE32HL(6P)</p>	<p>Power Controller SKP-32BC-60W (not included F type series)</p>

### Specifications

Model	SKD-BN512L SKD-BNK512L	SKD-BN512P SKD-BNK512P	SKD-BN512LF SKD-BNK512LF	SKD-BN512PF SKD-BNK512PF	SKD-BN517L/PF SKD-BNK517L/PF	SKD-BN519L/P SKD-BNK519L/P	
Input Voltage	DC24V or DC32V						
Power Consumption	55W						
Torque	(kgf.cm)	1.5~12	2~12	1.5~12	2~12	3~17	3~19
	(Lbf.in)	1.33~10.44	1.77~10.44	1.33~10.44	1.77~10.44	2.57~14.78	2.57~16.46
	(N.m)	0.15~1.18	0.2~1.18	0.15~1.18	0.2~1.18	0.29~1.67	0.29~1.86
Repeatable Torque Accuracy(%)	±3% (torque test in scale 4 with auxiliary arm)						
Torque Adjustment	Stepless						
Free Speed (r.p.m)	HI	1000	1000	2000	2000	2000	1000
	LO	700	700	—	—	—	700
Screw Size Dia (mm)	Machine Screw	1.6~3.0	1.6~3.0	1.6~3.0	1.6~3.0	1.6~3.0	2.3~3.5
	Tapping Screw	1.6~2.6	1.6~2.6	1.6~2.6	1.6~2.6	1.6~2.6	2.3~3.0
Weight(g)	520						
Length(mm)	235						
ESD(Anti-Static)	✓ (with black housing)						
CE	✓						
RoHS	✓						
Bit Type							

# BRUSHLESS LOW TORQUE DC-TYPE AUTOMATIC WITH COUNTER TRIGGER AND PUSH START CLUTCH TYPE SERIES SKD-BE200 Series

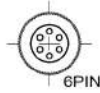
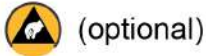

- Brushless motor, the perfect combination of screw counter and electric screwdriver, and most fit for operating in the clean room environment.
- Torque range from 0.2~10Kgf.cm is medium & small-sized screwdrivers. Widespread and extensively applied by users.
- SKD-BE series is one compact of LED counter and electric screwdriver. easy to operate, suitably used on production line and effectively control numbers of fastening screws and operation quality.
- Easy to set up, complete function, user can set up this counter according to needs of work and leave system automatically to inspect the precision of fastened screws.
- This system can set up Effective Count Number(SC), Automatic Zero(At), Slow Start Time(RC), Slow Start Speed(L0), Start Detect Time(Lt), Stop Time(Ht), Double Confirm Time after Fastening(LL), Waiting Time between Two Screws. Professional designs for the needs of users.
- Automatic Learning can complete necessary time from start to fasten, let user confirm whether it is an ideal fastening value.
- Signal output by OK ALL/OK ONE/N.G. in the screwdrivers, open collector. The user can select another wire to connect PLC if necessary.
- If start time doesn't stop as over Ht time, that means stripped or wrong screw ; If start time stops before Lt time, that means screws stuck or wrong. This function can effectively determine whether screw fastening is right or wrong.
- After setting up screws fastening, shut-off can be confirmed just one time during pre-set time.
- CE and ETL are optional

## External Dimension

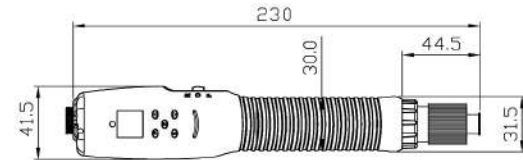
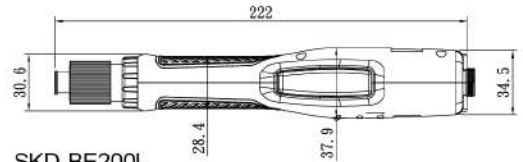

## Torque Range Reference Chart

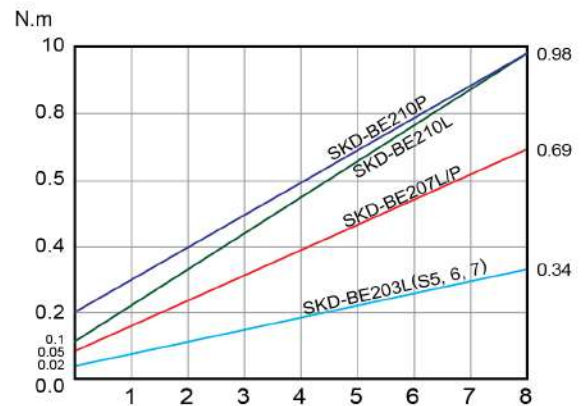

## Specifications

Model		SKD-BE203L	SKD-BE203LS5	SKD-BE203LS6	SKD-BE203LS7	SKD-BE207L	SKD-BE210L/P
Input Voltage		DC24V or DC32V					
Power Consumption		25W					
Torque	(kgf.cm)	0.2~3.5	0.2~3.5	0.2~3.5	0.2~3.5	0.5~7	L: 1~10 / P: 2~10
	(Lbf.in)	0.18~3.01	0.18~3.01	0.18~3.01	0.18~3.01	0.44~6.10	L: 0.89~8.67 / P: 1.77~8.67
	(N.m)	0.02~0.34	0.02~0.34	0.02~0.34	0.02~0.34	0.05~0.69	L: 0.10~0.98 / P: 0.2~0.98
Repeatable Torque Accuracy(%)		±3% (torque test in scale 4 with auxiliary arm)					
Torque Adjustment		Stepless					
Free Speed (r.p.m)	HI	1000	500	370	230	1000	1000
	LO	700	350	260	160	700	700
Screw Size Dia (mm)	Machine Screw	1.0~2.3	1.0~2.3	1.0~2.3	1.0~2.3	1.4~2.6	1.6~3.0
	Tapping Screw	1.0~2.0	1.0~2.0	1.0~2.0	1.0~2.0	1.4~2.3	1.6~2.6
Weight(g)		330					
Length(mm)		LC:226 / LB:240 / P:230					
ESD(Anti-Static)		✓ (with black housing)					
CE		✓					
RoHS		✓					
Bit Type		B		C			

## Accessories



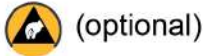

- Brushless motor, the perfect combination of screw counter and electric screwdriver, and most fit for operating in the clean room environment.
- Torque range from 1.5~19Kgf.cm is medium & small-sized screwdrivers. Widespread and extensively applied by users.
- SKD-BE series is one compact of LED counter and electric screwdriver. Two-color housing, easy to operate, suitably used on production line and effectively control numbers of fastening screws and operation quality.
- Easy to set up, complete function, user can set up this counter according to needs of work and leave system automatically to inspect the precision of fastened screws.
- This system can set up Effective Count Number(SC), Automatic Zero(At), Start Detect Time(Lt), Stop Time(Ht), Double Confirm Time after Fastening(LL), Waiting Time between Two Screws. Professional designs for the needs of users.
- Automatic Learning can complete necessary time from start to fasten, let user confirm whether it is an ideal fastening value.
- Signal output by OK ALL/OK ONE/N.G. in the screwdrivers, open collector. The user can select another wire to connect PLC if necessary.
- If start time doesn't stop as over Ht time, that means stripped or wrong screw ; If start time stops before Lt time, that means screws stuck or wrong. This function can effectively determine whether screw fastening is right or wrong.
- After setting up screws fastening, shut-off can be confirmed just one time during pre-set time.
- CE and ETL are optional

### External Dimension

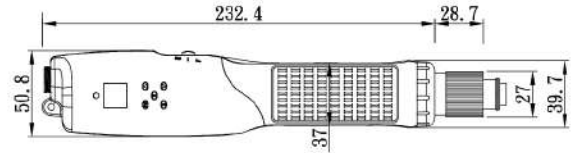

SKD-BE500P

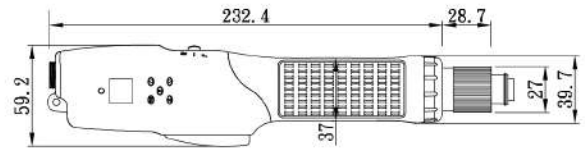

SKD-BE500L

### Torque Range Reference Chart

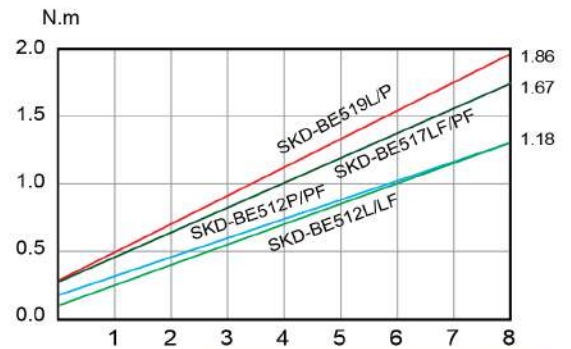

### Accessories

<p>Torque Locker KC-6C</p>	<p>Torque Adjuster KW-3</p>
<p>Screwdriver Holder KH-4</p>	<p>Spring Balancer KL-1200</p>
<p>Power Controller SKP-32BC-60W (not included F type series)</p>	<p>Pistol Grip LG-11, PG-11</p>
<p>SKP-BE32HL(6P)</p>	

### Specifications

Model	SKD-BE512L	SKD-BE512P	SKD-BE512LF	SKD-BE512PF	SKD-BE517LF	SKD-BE517PF	SKD-BE519L	SKD-BE519P	
Input Voltage	DC24V or DC32V								
Power Consumption	55W								
Torque	(kgf.cm)	1.5~12	2~12	1.5~12	2~12	3~17	3~17	3~19	3~19
	(Lbf.in)	1.33~10.44	1.77~10.44	1.33~10.44	1.77~10.44	2.57~14.78	2.57~14.78	2.57~16.46	2.57~16.46
	(N.m)	0.15~1.18	0.2~1.18	0.15~1.18	0.2~1.18	0.29~1.67	0.29~1.67	0.29~1.86	0.29~1.86
Repeatable Torque Accuracy(%)	±3% (torque test in scale 4 with auxiliary arm)								
Torque Adjustment	Stepless								
Free Speed (r.p.m)	HI	1000	1000	2000	2000	2000	2000	1000	1000
	LO	700	700	-	-	-	-	700	700
Screw Size Dia (mm)	Machine Screw	1.6~3.0	1.6~3.0	1.6~3.0	1.6~3.0	1.6~3.0	1.6~3.0	2.3~3.5	2.3~3.5
	Tapping Screw	1.6~2.6	1.6~2.6	1.6~2.6	1.6~2.6	1.6~2.6	1.6~2.6	2.3~3.0	2.3~3.0
Weight(g)	580								
Length(mm)	270								
ESD(Anti-Static)	✓ (with black housing)								
CE	✓								
RoHS	✓								
Bit Type									

**\*\*Please contact with your agent for special customization version.**

# BRUSHLESS LOW TORQUE DC-TYPE AUTOMATIC VACUUM SCREWDRIVERS

## SKD-BN200 (VACUUM TYPE) Series



### External Dimension

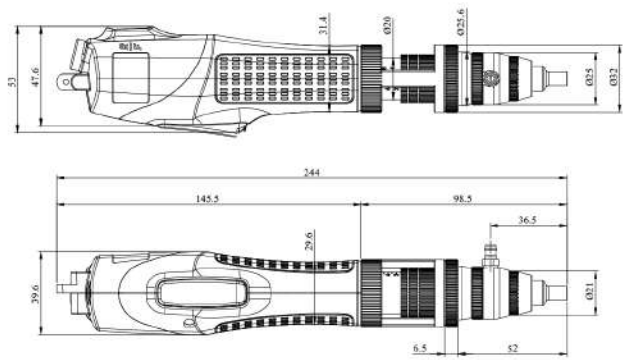

- Vacuum screwdriver was taking the series of SKD-BN200L/P as reference and being created by adding the vacuum head. The main purpose is sucking the non-magnetic screws, such as plastic screws / aluminum-made screws / stainless steel screws and any other screws that does not contain magnetic.
- Any type and specification of screws can be sucked which only need to replace the head to KS-2B.
- The suction of vacuum pump is powerful; if the screws tray is using together, it will be more convenient and easy. The screws can be placed at the tray first and then sucked by the vacuum screwdriver.
- CE and ETL are optional

### Specifications

Mode		SKD-BN203L(VACUUM TYPE)	SKD-BN207L(VACUUM TYPE)	SKD-BN210L/P(VACUUM TYPE)	SKD-BN203LS6(VACUUM TYPE)	SKD-BN203LS6(VACUUM TYPE)	SKD-BN203LS7(VACUUM TYPE)
Input Voltage		DC24V or DC32V					
Torque	(kgf.cm)	0.2~3.5	0.5~7	L: 1~10 / P: 2~10	0.2~3.5	0.2~3.5	0.2~3.5
	(Lbf.in)	0.18~3.01	0.44~6.10	L: 0.89~8.67 / P: 1.77~8.67	0.18~3.01	0.18~3.01	0.18~3.01
	(N.m)	0.02~0.34	0.05~0.69	L: 0.10~0.98 / P: 0.2~0.98	0.02~0.34	0.02~0.34	0.02~0.34
Repeatable Torque Accuracy(%)		±3% (torque test in scale 4 with auxiliary arm)					
Torque Adjustment		Stepless					
Free Speed (r.p.m)	HI	1000	1000	1000	500	370	230
	LO	700	700	700	350	260	160
Screw Size Dia (mm)	Machine Screw	1.0~2.3	1.4~2.6	1.6~3.0	1.0~2.3	1.0~2.3	1.0~2.3
	Tapping Screw	1.0~2.0	1.4~2.3	1.6~2.6	1.0~2.0	1.0~2.0	1.0~2.0
Power Consumption		25W					
Weight(g)		385					
Length(mm)		234					
ESD(Anti-Static)		✓ (with black housing)					
CE		✓					
RoHS		✓					
Power Controller		SKP-32BC-60W					
Bit Type							



(optional)

### External Dimension

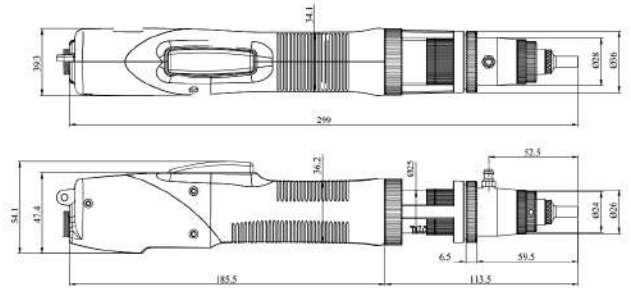

- Vacuum screwdriver was taking the series of SKD-BN500L/P as reference and being created by adding the vacuum head. The main purpose is sucking the non-magnetic screws, such as plastic screws / aluminum-made screws / stainless steel screws and any other screws that does not contain magnetic.
- Any type and specification of screws can be sucked which only need to replace the head to KS-5B.
- The suction of vacuum pump is powerful; if the screws tray is using together, it will be more convenient and easy. The screws can be placed at the tray first and then sucked by the vacuum screwdriver.
- CE and ETL are optional



### Specifications

Model	SKD-BN512L (VACUUM TYPE)	SKD-BN512P (VACUUM TYPE)	SKD-BN519L/P (VACUUM TYPE)	SKD-BN517L/P/PF (VACUUM TYPE)	SKD-BN512LF (VACUUM TYPE)	SKD-BN512PF (VACUUM TYPE)	
Input Voltage	DC24V or DC32V						
Torque	(kgf.cm)	1.5~12	2~12	3~19	3~17	1.5~12	2~12
	(Lbf.in)	1.33~10.44	1.77~10.44	2.57~16.46	2.57~14.78	1.32~10.44	1.77~10.44
	(N.m)	0.15~1.18	0.2~1.18	0.29~1.86	0.29~1.67	0.15~1.18	0.2~1.18
Repeatable Torque Accuracy(%)	±3% (torque test in scale 4 with auxiliary arm)						
Torque Adjustment	Stepless						
Free Speed (r.p.m)	HI	1000	1000	1000	2000	2000	2000
	LO	700	700	700	—	—	—
Screw Size Dia (mm)	Machine Screw	1.6~3.0	1.6~3.0	2.3~3.5	1.6~3.0	1.6~3.0	1.6~3.0
	Tapping Screw	1.6~2.6	1.6~2.6	2.3~3.0	1.6~2.6	1.6~2.6	1.6~2.6
Power Consumption	55W						
Weight(g)	603						
Length(mm)	300						
ESD(Anti-Static)	✓ (with black housing)						
CE	✓						
RoHS	✓						
Power Controller	SKP-32BC-60W			SKP-BE32HL(6P)			
Bit Type							

### Bit nozzle specification

PART NO	d1	d2	D	H	Applicable Model
P11032-7	2.2	3.2	4.2	1.3	BN200
P11032-8	2.7	4.2	5.2	1.3	
P11032-9	3.2	5	6	1.3	
P11032-10	3.5	5.5	6.5	1.3	
P11032-11	4.5	6.5	7.5	1.5	
P11032-15	3.5	5.5	6.5	2	BN500
P11032-17	4.5	6.5	7.5	2	
P11032-18	5.5	7.5	8.5	2	

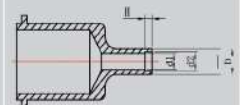

# BRUSHLESS HIGH TORQUE DC-TYPE AUTOMATIC TRIGGER AND PUSH START CLUTCH TYPE SERIES

## SKD-BN7000 Series



 (optional)



### External Dimension

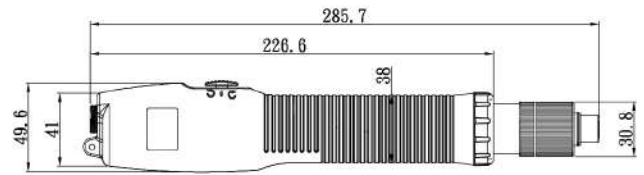

SKD-BN7000P

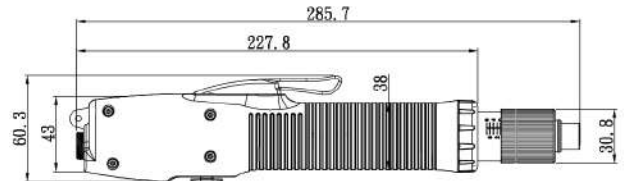

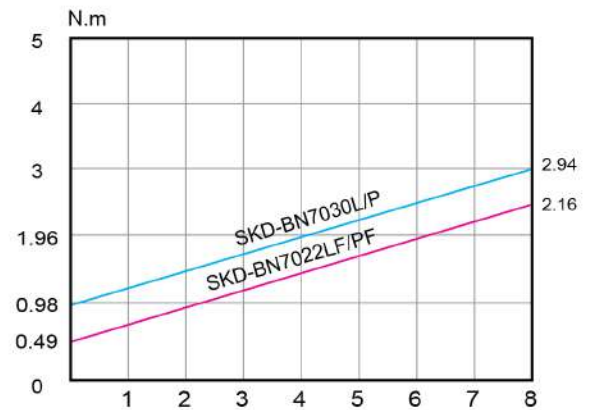

SKD-BN7000L

### Torque Range Reference Chart



- Brushless feature is applicable in a clean-room environment. The output of torque is highly stable. It is not only a easy-operate equipment but also be operated continuously for a long period.
- One LED on the housing is to remind the operators that the screwdriver is connecting to the power controller.
- Besides, it is a non-carbon, low-noise equipment, and low voltage.
- The best choice when composing the vertical's internal parts and/or any large-size electric equipments, including home appliances, LED/LCD panels and etc.
- CE and ETL are optional

### Specifications

Model		SKD-BN7022LF/PF	SKD-BN7030L/P
Input Voltage		DC24V/32V	
Power Consumption		55W	
Torque	(kgf.cm)	5~22	10~30
	(Lbf.in)	4.33~19.12	8.67~26.02
	(N.m)	0.49~2.16	0.98~2.94
Repeatable Torque Accuracy(%)		±3% (torque test in scale 4 with auxiliary arm)	
Torque Adjustment		Stepless	
Free Speed (r.p.m)	HI	2000	1200
	LO	-	-
Screw Size Dia (mm)	Machine Screw	2.6~4.0	2.6~4.0
	Tapping Screw	2.6~3.5	2.6~3.5
Weight(g)		790	
Length(mm)		290	
ESD(Anti-Static)		✓ (with black housing)	
CE		—	✓
RoHS		✓	
Power Controller		SKP-BE32HL(6P)	
Bit Type		 	

### Accessories







- AC plug ; no adaptor needed.
- Torque range 1.5~22kgf.cm.
- Adopts High-Functional Brushless Motor.
- Best fit for general machine screws operation.
- High rotation speed.

### External Dimension

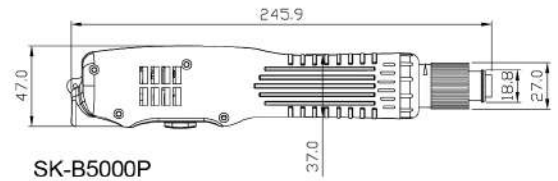
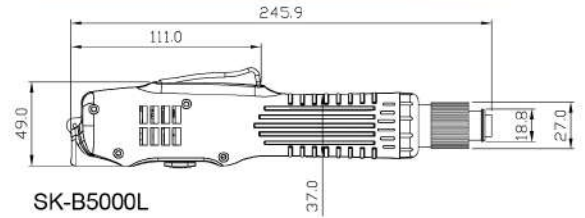

### Torque Range Reference Chart

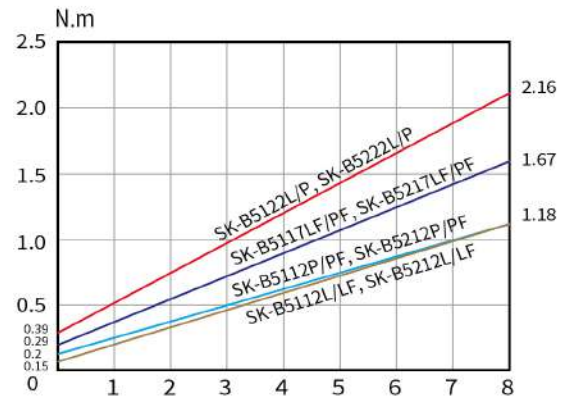

### Specifications

Model		SK-B5112L	SK-B5112LF	SK-B5117LF	SK-B5122L	SK-B5212L	SK-B5212LF	SK-B5217LF	SK-B5222L
		SK-B5112P	SK-B5112PF	SK-B5117PF	SK-B5122P	SK-B5212P	SK-B5212PF	SK-B5217PF	SK-B5222P
Input Voltage		AC110~120V 50/60Hz				AC220~240V 50/60Hz			
Torque	(kgf.cm)	L:1.5~12 P:2~12	L:1.5~12 P:2~12	3~17	4~22	L:1.5~12 P:2~12	L:1.5~12 P:2~12	3~17	4~22
	(Lbf.in)	L:1.33~10.44 P:1.77~10.44	L:1.33~10.44 P:1.77~10.44	2.57~14.78	3.52~19.12	L:1.33~10.44 P:1.77~10.44	L:1.33~10.44 P:1.77~10.44	2.57~14.78	3.52~19.12
	(N.m)	L0.15~1.18 P:0.2~1.18	L0.15~1.18 P:0.2~1.18	0.29~1.67	0.39~2.16	L0.15~1.18 P:0.2~1.18	L0.15~1.18 P:0.2~1.18	0.29~1.67	0.39~2.16
Repeatable Torque Accuracy (%)		±3% (torque test in scale 4 with auxiliary arm)							
Torque Adjustment		Stepless							
Free Speed(r.p.m)		1200	2000	2000	1200	1200	2000	2000	1200
Power Consumption		0.4A				0.2A			
Screw Size Dia (mm)	Machine Screw	1.6~3.0	1.6~3.0	1.6~3.5	2.3~4.0	1.6~3.0	1.6~3.0	1.6~3.5	2.3~4.0
	Tapping Screw	1.6~2.6	1.6~2.6	1.6~3.0	2.3~3.5	1.6~2.6	1.6~2.6	1.6~3.0	2.3~3.5
Weight(g)		470							
Length(mm)		245							
ESD(Anti-Static)		-							
ETL		✓				-			
CE		-				✓			
RoHS		✓							
Bit Type									

### Accessories

Torque Locker  
KC-6C



Torque Adjuster  
KW-3



Screwdriver Holder  
KH-4



Spring Balancer  
KL-1200



90 Degree Attachment  
KL-2



# BRUSHLESS HIGH TORQUE AC-TYPE AUTOMATIC TRIGGER AND PUSH START CLUTCH TYPE SERIES

## SK-B6 Series



### External Dimension

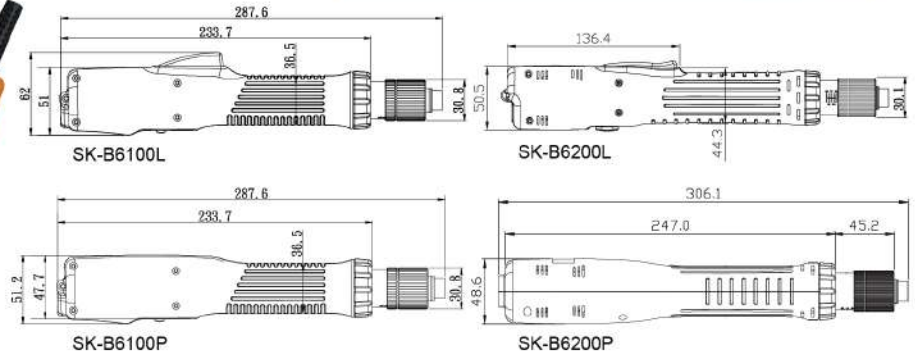

### Torque Range Reference Chart

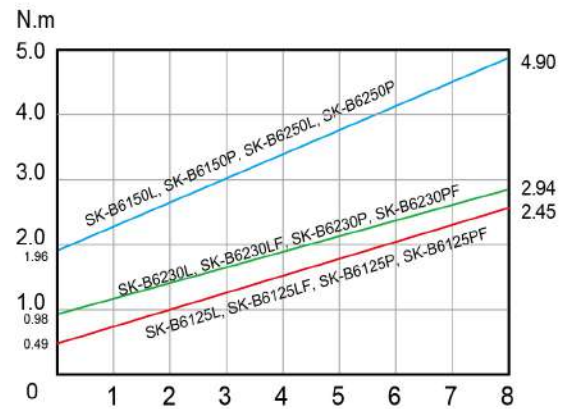

- AC plug ; no adaptor needed.
- Torque range 5~50kgf.cm.
- Adopts High-Functional Brushless Motor.
- Best fit for general machine screws operation.
- High rotation speed.

### Specifications

Model		SK-B6125L SK-B6125P	SK-B6125LF SK-B6125PF	SK-B6150L SK-B6150P	SK-B6230L SK-B6230P	SK-B6230LF SK-B6230PF	SK-B6250L SK-B6250P
Input Voltage		AC110~120V 50/60Hz			AC220~240V 50/60Hz		
Torque	(kgf.cm)	5~25	5~25	20~50	10~30	10~30	20~50
	(Lbf.in)	4.34~21.68	4.34~21.68	17.35~43.37	8.8~26.02	8.8~26.02	17.35~43.37
	(N.m)	0.49~2.45	0.49~2.45	1.96~4.90	0.98~2.94	0.98~2.94	1.96~4.90
Repeatable Torque Accuracy(%)		±3% (torque test in scale 4 with auxiliary arm)					
Torque Adjustment		Stepless					
Free Speed(r.p.m)		1000	2000	1000	1200	2000	1200
Power Consumption		0.5A			0.3A		
Screw Size Dia (mm)	Machine Screw	2.6~4.0	2.6~4.0	4.0~5.0	2.6~4.0	2.6~4.0	4.0~5.0
	Tapping Screw	2.6~3.5	2.6~3.5	≤4	2.6~3.5	2.6~3.5	≤4
Weight(g)		500			810		
Length(mm)		285			305		
ESD(Anti-Static)		-			-		
ETL		✓			-		
CE		-			✓		
RoHS		-			✓		
Bit Type							

### Accessories



# KILEWS® SCREW COUNTER (FOR BRUSHLESS SCREWDRIVERS) INTRODUCTION/FEATURES

## Introduction

In order to achieve accurate counting on screw fastening and work together with PLC based process control, KILEWS integrate screw counter, power supply, and slow start function into unique device which is both power supply and screw counter as well. Our screw counters are designed more conveniently and perfectly to meet users' practicability and availability.



## Features of SKP-BC32HL-100

- High / Low speed switch / Hi/Lo voltage switch protection function
- Slow start time (0.0-9.9 second)
- Slow start speed Level (L0: 100%, 35%~85% L1~L9 Rated speed)
- Target reached Confirm (enable / disable)
- Input / Output function control
- External start Input Control
- External reverse Input Control
- External enable Input Control
- External confirm Input Control
- Expanding 5 sets data memory
- Auto-Learning function for time monitoring
- Before tightening reverse
- After tightening reverse
- Counting mode (count up / count down)
- Signal output (OK 1/ OK ALL / NG)
- Cancel NG signal (Use external Clear or Confirm button to cancel NG signal)
- Operation complete time
- Self locking when counter detect error (enable / disable)
- Sensor mode (Applications according to different operation use)
- Error code by monitoring
- Strong anti-interference capability

\*\*Please contact with your agent for special customization version.



# SCREW COUNTER (FOR BRUSHLESS SCREWDRIVERS)

## SKP-BC32HL-100 [Counter / Power Supply / Slow-Start]



### EXTERNAL DIMENSION

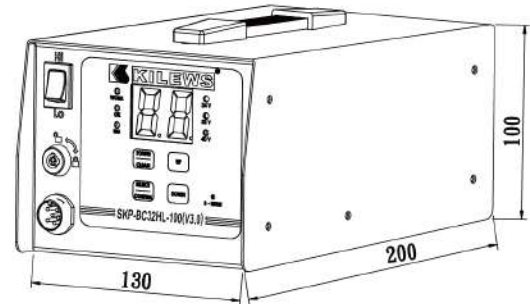

### Specifications

Model	<b>SKP-BC32HL-100</b>
Input Voltage	AC 100~240V 50/60HZ
Output Voltage	DC 32V / 24V 1.875A
Power Consumption	60W
Count	1~99
Count method	Count-up / Count-down
Work with Sensor	ON / OFF
GATE Sensor	ON(2 Sensors) / OFF(1 Sensor)
Slow-start time adjustable	0~9.9 seconds
Slow-start speed adjustable	L0 : 100%, 35%~85% L1~L9 Rated speed
Running Time limit-LO	0.00~9.99 seconds
Running Time limit-HI	0.0~9.9 seconds
Reminder Mode	ON / OF / FF / EF with LED and buzzer
Auto ZERO	ON / OFF
External inputs	Forward / Reverse / Disable / Confirm / Sensor / Clear
External outputs	OK / NG / OK ALL
Screwdriver Control	HI / LO : Slow-Start
Outside Dimensions	200X130X100(mm)
Weight(Kg)	1.57
Accessories	Power cordX1 · KeyX2
Remark	  
Applicable Models	SKD-BN200(Series) SKD-BN500(Series) SKD-BN7000(Series)



# KILEWS® TORQUE METERS

## KTM-6, KTM-15, KTM-150



KTM-6 / 15 / 150



- The torque meters are directly produced in Japan, authorized by Kilews Industrial Co., Ltd. by ODM. Each product will be provided with an Adjustment Certificate and one year warranty in normal using. Take Note! These measuring instruments could not be applied in testing the pneumatic screwdriver products and prohibited in measuring the torque exceeding maximum measuring range of torque meters.

### KTM-6, KTM-15, KTM-150

- LED can identify the test range of torque setting by needed user. If the result is not complying to torque range setting, light will be warned.
- USB connector is only used for data output ; it is convenient for user to work with computer.
- Auto-zero can be selected and zero reset becomes unnecessary for user.
- Automatically test values about maximum, minimum and mean.
- ※Products are suitable for shut off type screwdriver only.

### Specifications

Model		KTM-6	KTM-15	KTM-150
Measuring Ranges	(kgf.cm)	0.02~8.0	0.15~15.0	1.5~150.0
	(Lbf.in)	0.02~7.0	0.15~13.0	1.5~130.0
	(N.m)	0.2~80.0 (cN.m)	0.015~1.500	0.15~15.0
Accuracy		+/- 0.5%		
Power Supply		4.8VDC (Ni-MH chargeable battery 1.2VX4 cell 1650mAh)		
Charging Time		From empty ~3 hours		
Operation Time		About 12 hours		
Battery Life		Chargeable for 300 times or more. However, it varies depending on operating conditions.		
Size(mm)		230(W)X125(D)X65(H)		
Weight(kg)		1.8	1.8	1.8
Exclusive Charger		Input : AC100V~240V 50/60Hz Output : DC12V 400mA		
Accessory		Torque measuring adaptorX1 AJ-3	Torque measuring adaptorX2 AJ-15 / AJ-3	Torque measuring adaptorX3 AJ-150 / AJ-50 / AJ-15K

# SCREW FEEDER (FOR VACUUM TYPE SCREWDRIVER AND AUTOMATION SYSTEM)

KFA-0820 Series [KFA-0820A, KFA-0820H]



**KFA-0820H**  
(PICK UP TYPE)

Prompt delivery and steady screw feeding are the important factors of a screw feeder. We have collected feedbacks from all brands users for their opinions to develop this screw feeder. We integrated our advantages with other brands and eliminated detriments that occurred on other brands. As the result, win situation is provided to both our distributors and customers. Please read operation manual before operating in order to achieve the max value of the screw feeder.

## Other functions

PCB designed with short circuit and over load protection. Screw feeder and PCB grounding connection is also available. Power On/Off buzzer alert and blinking LED indicator.

## Specifications

Model Name & Number	KFA-0820 Automatic Screw Feeder
Size	160(L)X82(W)X112(H) mm
Weight	1.53kg (w/o adapter)
Power Source	AC 100~240V
Switching Adaptor	DC 12V Switching Adaptor
Applicable Screw	From M1.2~M2.0
Applicable Screw Length	≤7mm
Horizontal Delivery Speed	42~90 pcs/min (0.7~1.3 Sec)
Feeding	Chamber Blanking
Scooping Chamber Capacity	4000pcs (for M1.4X4) / 1200pcs (for M2.0X5)

## Features

- WIDEST RANGE OF APPLICABLE SCREW SIZES :**  
 Between 1.2~2.0mm (Incl. : 1.2mm, 1.4mm, 1.7mm, 2.0mm) 4 sizes.
- MAX OF SCREWS LENGTH & HOPPER CAPACITY :**  
 Screw Length : Up to 7mm (under screw head)  
 Capacity of hopper : 4000pcs (for M1.4X4) / 1200pcs (for M2.0X5)
- APPLICABILITY OF SPECIAL SCREW TYPES :**  
 Screw Length : Thread Diameter (1=1, 1<1)  
 Thickness of screw head 0.2mm  
 No jamming or failure occurred with these applicable types and affect productivity.
- BRUSHLESS MOTOR :**  
 Adopting durable made in Japan brushless motor.
- ADJUSTABLE RAILWAY :**  
 High precision wire cut adjustable railway. Adjustable rail, screw size from 0.8mm up to 2.0mm.
- CIRCULAR LOOP FEEDING :**  
 Circular loop feeding, adopting durable aluminum extruded rail.  
 Screws are carried on a circular track for smooth feeding.
- ADOPTING MULTI-FUNCTIONAL :**  
 Adopting multi-functional smart PCB with material shortage alert and screw taking counting function in digital display. ( Please contact our service center for detail information.)
- SIGNAL OUTPUT FUNCTION :**  
 With screws in position signal output function.



**KFA-0820A**  
(VACUUM TYPE)



**KFA-0850A  
(VACUUM TYPE)**

Prompt delivery and steady screw feeding are the important factors of a screw feeder. We have collected feedbacks from all brands users for their opinions to develop this screw feeder. We integrated our advantages with other brands and eliminated detriments that occurred on other brands. As the result, win situation is provided to both our distributors and customers. Please read operation manual before operating in order to achieve the max value of the screw feeder.

### Other functions

PCB designed with short circuit and over load protection. Screw feeder and PCB grounding connection is also available. Power On/Off buzzer alert and blinking LED indicator.

### Specifications

Model Name & Number	KFA-0830	KFA-0850
Size	182(L)X124(W)X146(H) mm	182(L)X124(W)X150(H) mm
Weight	3.0kg (w/o adapter)	3.1kg (w/o adapter)
Power Source	AC 100~240V	
Switching Adaptor	DC 12V Switching Adaptor	
Applicable Screw	From M0.8~M3.0	From M1.2~M5.0
Applicable Screw Length	≤15 mm	≤10mm
Applicable Screw Head Dia.	≤7 mm	≤7mm
Horizontal Delivery Speed	46~50 pcs/min (1.2~1.3 Sec)	42~90 pcs/min (0.7~1.5 Sec)
Feeding	Chamber Blanking	
Scooping Chamber Capacity	200~220 c.c	200~220 c.c

### Features

- WIDEST RANGE OF APPLICABLE SCREW SIZES:**  
 KFA-0830: Between 0.8~3.0mm (Incl. : 0.8mm, 1.0mm, 1.2mm, 1.4mm, 1.7mm, 2.0mm, 2.3mm, 2.6mm, 3.0mm) 9 sizes.  
  
 KFA-0850: Between 1.2~5.0mm (Incl. : 1.2mm, 1.4mm, 1.7mm, 2.0mm, 2.3mm, 2.6mm, 3.0mm, 3.5mm, 4.0mm, 5.0mm) 10 sizes.
- APPLICABILITY OF SPECIAL SCREW TYPES:**  
 Screw Length : Thread Diameter (1=1, 1<1)  
 Thickness of screw head 0.2mm  
 No jamming or failure occurred with these applicable types and affect productivity.
- BRUSHLESS MOTOR:**  
 Adopting durable made in Japan brushless motor.
- CHANGEABLE RAILWAY:**  
 High precision wire cut adjustable railway. Adjustable rail, screw size from 0.8mm up to 5.0mm.
- HORIZONTAL LINEAR FEEDING:**  
 Horizontal linear feeding, adopting durable aluminum extruded rail. Screws are carried on a horizontal track for smooth feeding.
- ADOPTING MULTI-FUNCTIONAL:**  
 Adopting multi-functional smart PCB with material shortage alert and screw taking counting function in digital display. ( Please contact our service center for detail information. )
- SIGNAL OUTPUT FUNCTION:**  
 With screws in position signal output function.



**KFA-0850H  
(PICK UP TYPE)**



**KFA-0830**

# SCREW FEEDER KFR-1050



Prompt delivery and steady screw feeding are the important factors of a screw feeder. We have collected feedbacks from all brands users for their opinions to develop this screw feeder. We integrated our advantages with other brands and eliminated detriments that occurred on other brands. As the result, win situation is provided to both our distributors and customers. Please read operation manual before operating in order to achieve the max value of the screw feeder.

## Specifications

Model Name & Number	KFR-1050 Automatic Screw Feeder
Size	182(L)X126(W)X147(H) mm
Weight	2.5 Kg (w/o adapter)
Power Source	AC 100~240V
Switching Adaptor	DC 15V Switching Adaptor
Applicable Screw	From M1.0 to M5.0
Applicable Screw Length	Up to 19mm(under head)
Scooping Chamber Capacity	200~220 cc
Accessories (in package & box)	Allen Wrench (L Shaped 2.0 x 107 mm) X1 pc.
	Switching Adaptor x 1 Set.
	Accessory(front) (0.8 , 1.0 , 1.2 , 1.5 , 2.0 x 70 mm)X1 pc.
	Accessory(behind) (0.2 x 10 x 20 mm)X2 pcs (0.5 x 10 x 20 mm)X10 pcs.
	Stopper 2.0~5.0mmX1 pc.
	Instruction Manual
Package Size	Each Set/Box : 282(L)X142(W)X201(H)mm
	Each Carton : 450(L)X310(W)X435(H)mm
Package Weight (Including Machine)	Each Set/Box G.W : Approx 2.63 Kgs
	Each Carton G.W : Approx 16.53 Kgs(One Carton=6 Sets)

## Features

- WIDEST RANGE OF APPLICABLE SCREW SIZES :**  
 Between 1.0~5.0mm (Incl.; 1.0mm, 1.2mm, 1.4mm, 1.7mm, 2.0mm, 2.3mm, 2.6mm, 3.0mm, 3.5mm, 4.0mm, & 5.0mm,) 11 sizes.
- MAX OF SCREWS LENGTH & HOPPER CAPACITY :**  
 Screw Length : Up to 19mm (under screw head)  
 Capacity of hopper : 200~220 c.c
- APPLICABILITY OF SPECIAL SCREW TYPES :**  
 Screw Length  $\geq$  Thread Diameter (1=1, 1<1)  
 Thickness of screw head  $\geq$  0.2mm  
 No jamming or failure occurred with these applicable types and affect productivity.
- SIZE OF FEEDING RAIL IS ADJUSTABLE :**  
 Feeding rail can be pulled out for width adjusts to the applied sizes easily. Measurements for width adjusting can be in metric or imperial units.
- SAVE PARTS COSTS & STOCK :**  
 KFR-1050 allows adjusting the width of feeding rail to serve 11 sizes screws, between 1.0mm to 5.0mm diameter. The flexibility prevents dealers from stocking up on quantities for different sizes, and reduces the cost on related accessories for users.
- ADJUSTABLE VIBRATION INTENSITY :**  
 With vibration in small amplitude at high strength, it moves screws On rail to pick-up point in good order, no overlay or jamming to affect the speed of movement and productivity.
- HUMANIZED MULTI PROGRAMMING CONTROL :**  
 \*Individual drive system for feeding and vibrating operation.  
 \*Setting for suitable stop time without interapt to operate.  
 \*Equipped ground wire, socket & buzzer for operative safety and alarm signal.  
 \*PCB controls for efficiencies of desired speed & timing on each operating step.  
 \*Switching Adaptor allowed AC 100~240V power source for stable DC 15V output. No influences and problems due to the different AC power source of factories locations.

## Other functions

PCB designed with short circuit and over load protection. Screw feeder and PCB grounding connection is also available. Power On/Off buzzer alert and blinking LED indicator.

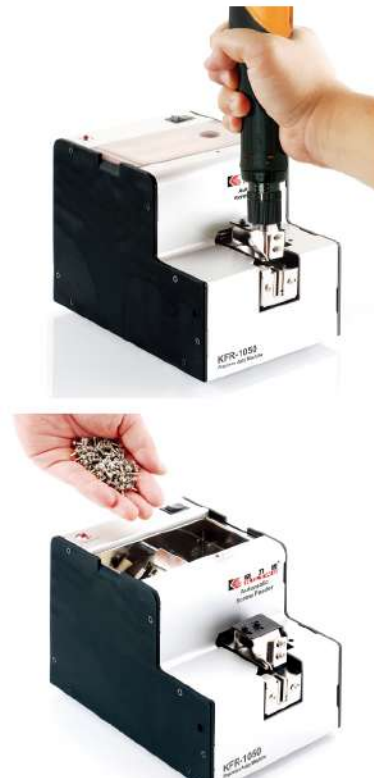



**Auxiliary Arm**

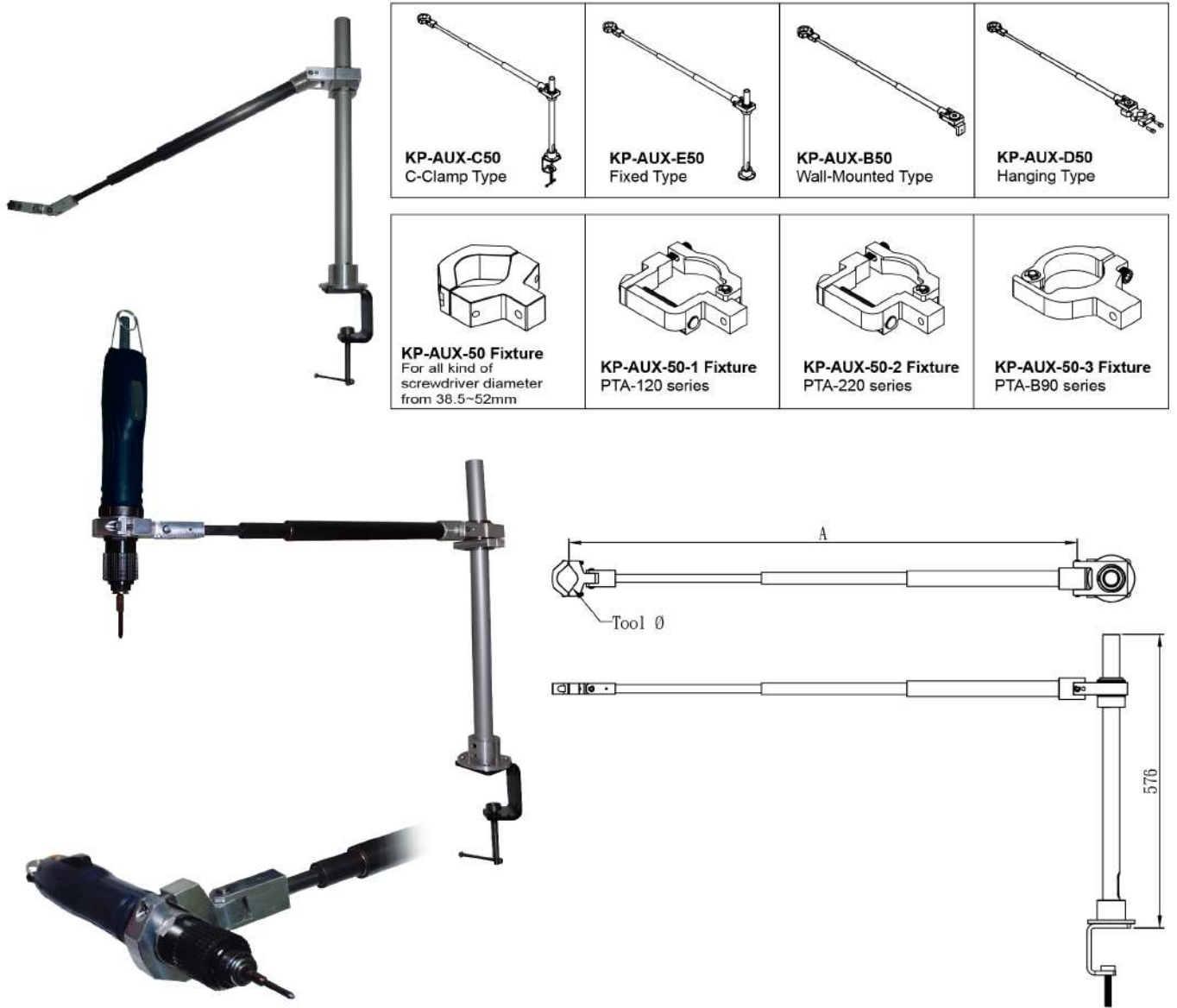

**Specifications**

Model No.	Max torque (Nm)	A(mini/maxi) cm	Tool Ø diameter(mm)
KP-AUX-C50-1000	50	43~100	38.5~52
KP-AUX-C50-1200	50	50~120	38.5~52
KP-AUX-E50-1000	50	43~100	38.5~52
KP-AUX-E50-1200	50	50~120	38.5~52
KP-AUX-B50-1000	50	43~100	38.5~52
KP-AUX-B50-1200	50	50~120	38.5~52
KP-AUX-D50-1000	50	43~100	38.5~52
KP-AUX-D50-1200	50	50~120	38.5~52

※Please inform which screwdriver series will be with the auxiliary arm before releasing order.

## ACCESSORIES



# Screwdriver I/O Signal Control Box (For Manual / PLC) 、 Slow Start Control Module 、 90 Degree Attachment

【KL-SCBSN, KL-SSBN, KL-1, KL-2, KZ-1, KL-4】

### Screwdriver I/O Signal Control Box (For Manual / PLC)



#### KL-SCBSN

- Slow Start time (0.0-9.9 second)
- Slow start Speed Level (30%-100% of normal speed, L0-L9)
- Operation Time (0.0-9.9 second)
- Target Reached Confirm (enable / disable)
- Brake Signal Hold Time (start off / next start off)
- External Start Input Control
- External Reverse Input Control
- Signal output (Start, Stop, Reverse)



SHIELDED CABLE



BN SCREWDRIVER



KL-SCBSN



OR



BN series Power Controller



### Slow Start Control Module

#### KL-SSBN

- BYPASS : Automatically disable slow start function when screwdriver in reverse rotation, easier to reverse screws.
- Adjustable slow start speed from 30% to 100% of normal speed, Slow start level setting from L1-L2-L3-....L9-L0
- Provide output start signal/ break signal/ forward and reverse signal with MOS relay switch
- Compatible with KILEWS Brushless DC SKD-BN series
- Slow start time can be set from 0.1 s up to 9.9 second
- Dimension : 58x95x35mm ( LxWxH)

#### 90 Degree Attachment Applicable Model

KL-1	SK-B6L Series, SKD-BN7000L Series
KL-2	SKD-BN500L Series, SK-B5L Series
KL-4	SKD-B123KLM

※ Only for "L" trigger start screwdrivers

#### 90 Degree Attachment



A

B

KL-1

A

B

KL-2

KL-4

	Screwdriver Holder	KH-2	KH-3	KH-4	KH-5	KH-2L
	Applicable Models	SKD-BN500 Series(&KC) SKD-BE500 Series(&KC) SK-B6 Series	SK-B5 Series(&KC)	SK-B5 Series SKD-BN500 Series SKD-BE500 Series	SKD-BN200Series SKD-BE200Series SKD-BN200Series(&KC) SKD-BE200Series(&KC)	SK-B6 Series(&KC) SKD-BN7000(&KC)

	Torque Locker	KC-6C(S)	KC-7C(S)	KC-9C(S)	KC-13C(S)	KC-2(S)
	Applicable Models	SK-B5 Series SKD-BN500 Series SKD-BE500 Series	SK-B6 Series	SKD-B100 Series	SKD-BN200Series SKD-BE200Series	SKD-BN7000 Series

ESD need special order (S) series.



### Spiral Cables

Supplying spiral cables for all of KILEWS screwdrivers with 4pin or 6pin. (B100/BN200 series are not included.)

 <div style="display: flex; justify-content: space-around; font-size: small;"> <div style="text-align: center;">KW-1</div> <div style="text-align: center;">KW-3</div> <div style="text-align: center;">KW-4</div> </div>		Suspension Rack	KW-1	KW-3	KW-4
		Applicable Models	SK-B6 Series SKD-BN7000 Series	SK-B5 Series SKD-BN500 Series SKD-BE500 Series	SKD-BN200Series SKD-BE200Series

	Pistol Grip	Applicable Models
	LG-10	SKD-BN500L Series
	PG-10	SKD-BN500P Series
	LG-11	SKD-BE500L Series
	PG-11	SKD-BE500P Series
	LG-14	SK-B6 for 220V L type only

	Screw Setter	Applicable Models
	KB-1	M1.7~2.0 Screw available
	KB-2	M2.0~2.6 Screw available
	KB-3	M3.0~4.0 Screw available

	Spring Balancer	Applicable Models
	KL-600 (0.3~0.6kg)	SKD-B100 Series, SKD-BN200 Series, SKD-BE200 Series
	KL-1200 (0.6~1.5kg)	USE FOR ALL MODELS (TBN, RBN, BK900, LRBK series are not included.)



Actual SKD-B100 series size

**INNOVATION FOR SCREWS FASTENING**

2019.08  
YT99936